



INSTALLATION INSTRUCTIONS

Accessory
CARGO COVER
P/N 08U35-SCV-110 (Black)
P/N 08U35-SCV-120 (Gray)

Application
2004 ELEMENT

Publications No.
All 26557
Issue Date
DEC 2003

Keep this information in the glove box for future reference.

PARTS LIST

Cargo cover

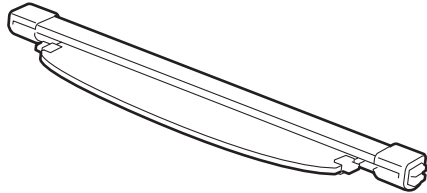

INSTALLATION

Installing the Cargo Cover

1. Open the rear hatch, and locate the recess in the left and right rear side trim panels.

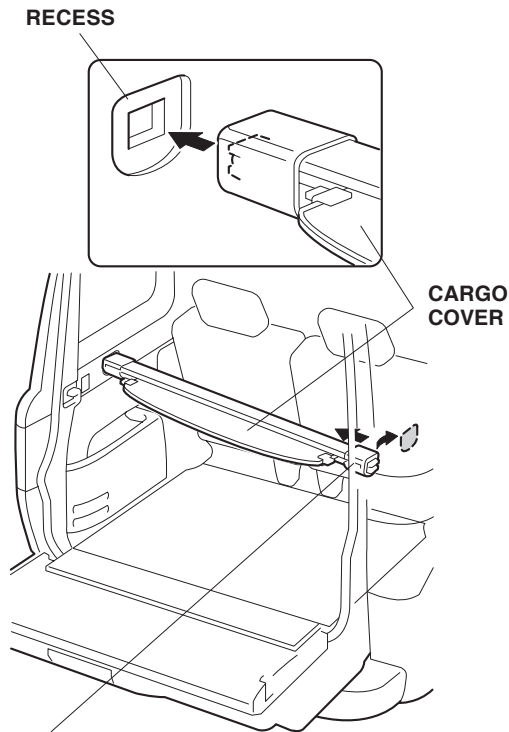

Slide the cargo cover in and forward.

2. Install the cargo cover into the recess in the left rear side trim panel, then compress the cargo cover, and install it in the recess in the right rear side trim panel.

3. Attach the right and left hooks to the rear side trim panels.

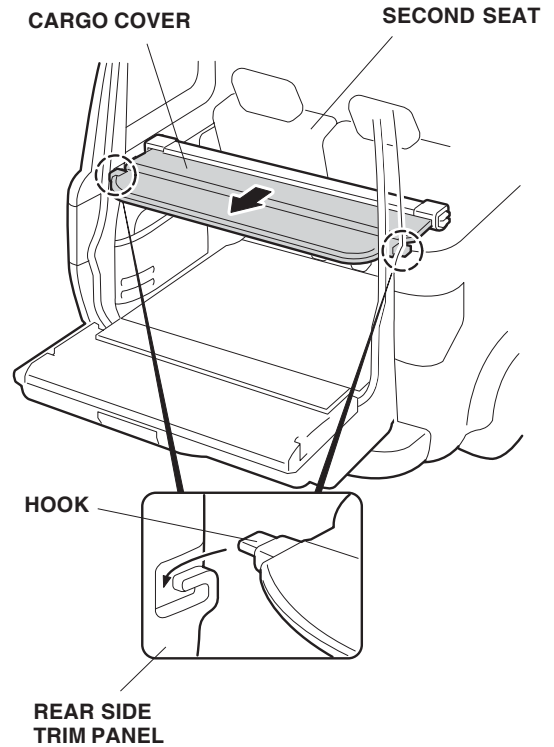

USE AND CARE

The cargo cover is spring loaded and can snap in when released from the hooks. When you retract the cargo cover to the storage position, unhook, release and retract the cover slowly.

CLEANING THE CARGO COVER

Use a sponge or cloth and a solution of mild liquid dishwashing soap and water, then wipe dry with a clean cloth or sponge.