



# INSTALLATION INSTRUCTIONS

Accessory

TABLE LEG KIT  
P/N 08Z05-SCV-100

Application

2004 ELEMENT

Publications No.

All 26588

Issue Date

DEC 2003

Keep this information in the glove box for future reference.

## PARTS LIST

Table legs

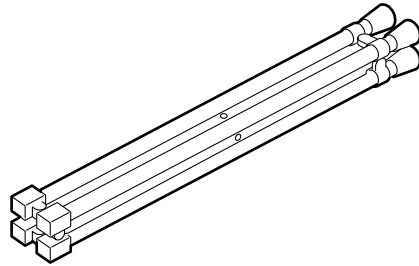

4 Holders

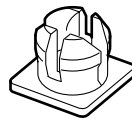

4 Washer screws



4 Nuts



## TOOLS REQUIRED

Phillips screwdriver

## INSTALLATION

1. Open the upper and lower tailgates and take out the cargo area floor (two hooks).

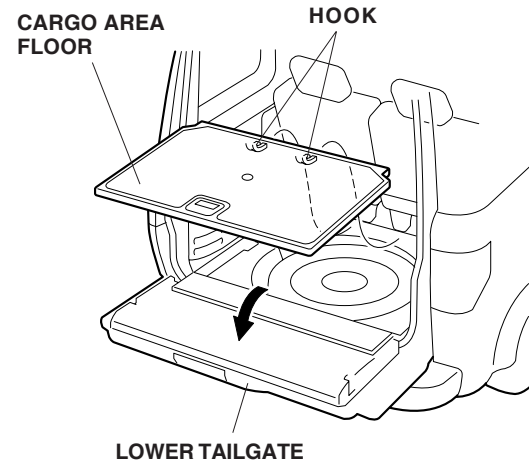

2. Turn the cargo area floor over and slide a nut into each of the four brackets as shown. Install the four holders on the brackets and secure each holder with a washer-screw.

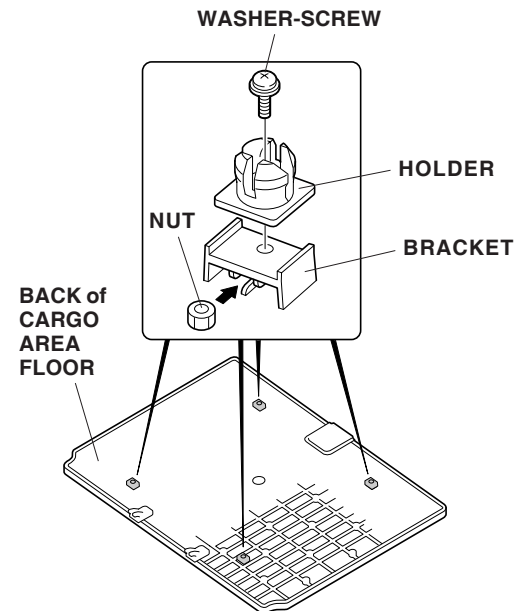

3. Unfold the table legs, and place the cargo area floor holders into the square holes of the table legs.

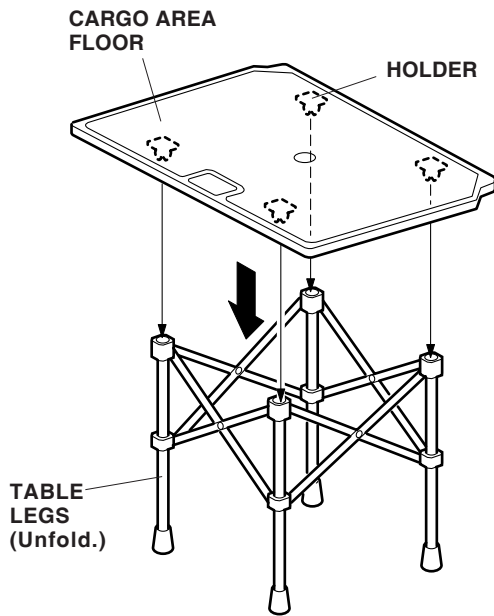

4. Confirm that the table legs and the holders have been installed securely.

#### **User's Information**

- Be sure to the legs are firmly attached to the table.
- Do not stand on the table.
- Do not put a weight of over 10 kg (22 lbs) on the table.
- Hot items such as pots, pans or kettles should not be placed directly on the table top.